



# RoboCupJunior Rescue Line Rules 2024 Draft

RoboCupJunior Rescue Committee 2023		
Chair	Tom Linnemann	Germany
	Tatiana Pazelli	Brazil
	Alexander Jeddeloh	Germany
	Diego Garza Rodriguez	Mexico
	Elizabeth Mabrey	USA
	Matej Novosad	Croatia
	Sarah Morgan	Canada

RoboCupJunior Exec 2023		Trustees representing RoboCupJunior	
Rui Baptista	Portugal	Luis José Lopez Lora	Mexico
Roberto Bonilla	USA	Irene Kipnis	Israel
Marco Dankel	Germany		
Margaux Edwards	Australia		
Shi Lee	China		
Julia Maurer	USA		
Marek Š uppa	Slovakia		

## Official Resources

<a href="#">RoboCupJunior Official Website</a>	<a href="#">RoboCupJunior Official Forum</a>	<a href="#">RCJ Rescue Community Website</a>
--	--	--

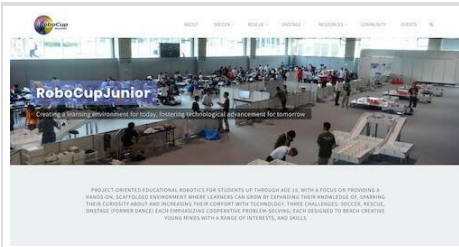

<https://junior.robocup.org>

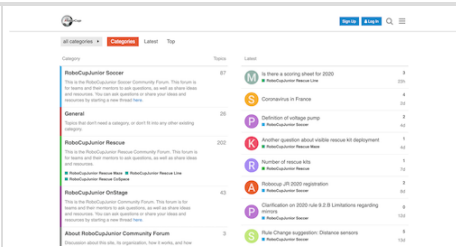

<https://junior.forum.robocup.org>



<https://rescue.rj.cloud>



Corrections and clarifications to the rules may be posted on the forum before updating this rule file. It is the responsibility of the teams to review the forum to have a complete vision of these rules.

# Before you read the rules



Please read through the [RoboCupJunior General Rules](#) before proceeding with these rules, as they are the premise for all rules. The English rules published by the RoboCupJunior Rescue Committee are the only official rules for RoboCupJunior Rescue Line 2024. The translated versions each regional committee can publish are only referenced information for non-English speakers to understand the rules better. It is the responsibility of the teams to read and understand the official rules.

## Scenario

The land is too dangerous for humans to reach the victims. Your team has been given a difficult task. The robot must be able to carry out a rescue mission in a fully autonomous mode with no human assistance. The robot must be durable and intelligent enough to navigate treacherous terrain with hills, uneven land, and rubble without getting stuck. <sup>[1]</sup> When the robot reaches the victims, it has to gently and carefully transport each one to the safe evacuation point <sup>[2]</sup> where humans can take over the rescue. The robot should exit the evacuation zone after a successful rescue to continue its mission throughout the disaster scene until it leaves the site. Time and technical skills are essential! Come prepared to be the most successful rescue team.

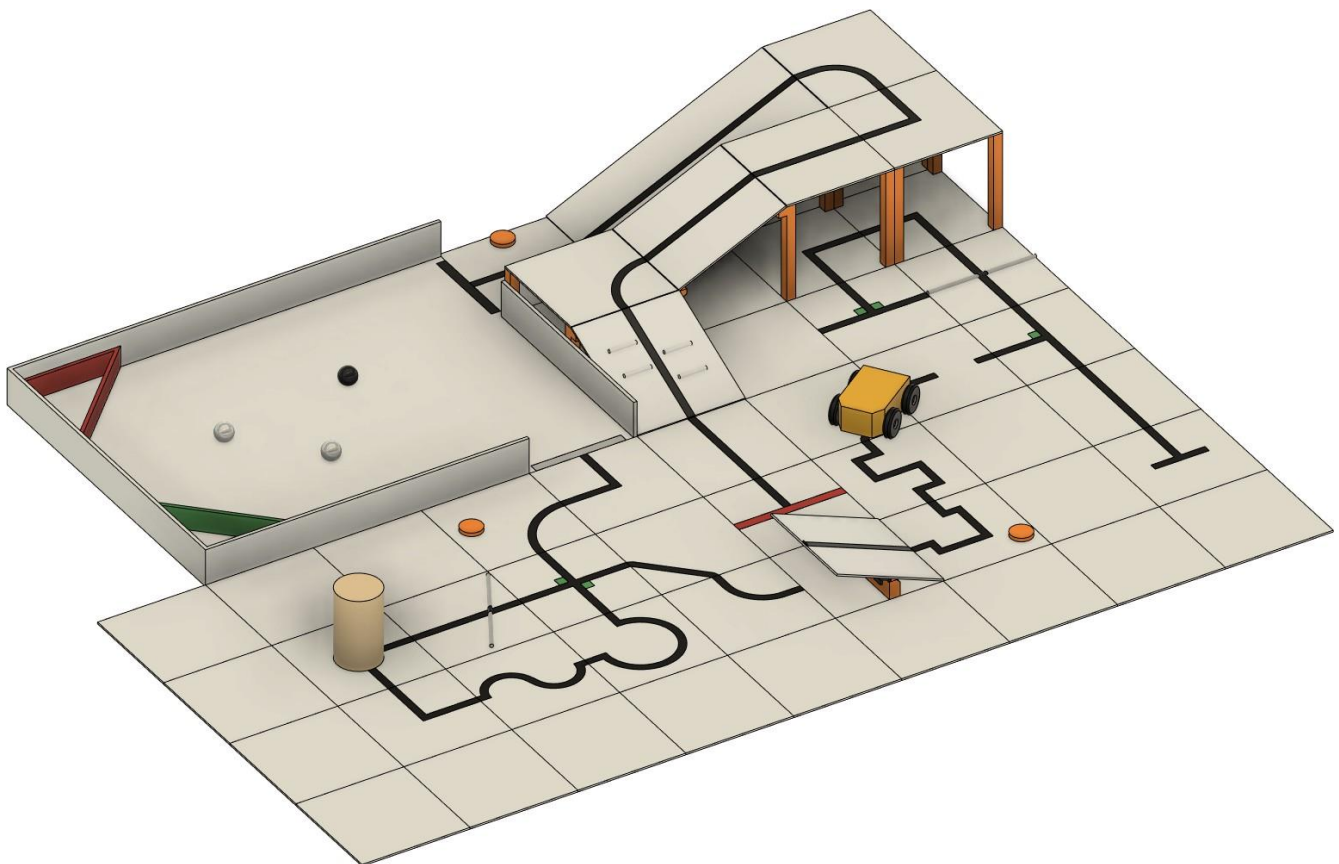

# Summary

An autonomous robot should follow a black line while overcoming problems in a modular field formed by tiles with different patterns. The floor is white, and the tiles are on different levels connected with ramps.

Teams are not allowed to give their robot any information in advance about the field as the robot is supposed to recognize the area by itself. The robot earns points as follows:

- 10 points for following the correct path on a tile at an intersection or a dead end.
- **20** <sup>[3]</sup> points for navigating through a seesaw tile.
- **20** <sup>[4]</sup> points for overcoming each obstacle (bricks, blocks, weights, and other large, heavy items). A robot is expected to navigate various obstacles.
- 10 points for reacquiring the line after a **tile with one or more gaps** <sup>[5]</sup>.
- 10 points for successfully navigating through a ramp (i.e., up or down successfully).
- **10** <sup>[6]</sup> points for negotiating a **tile with one or more speed bumps** <sup>[7]</sup>.

If the robot gets stuck in the field, it can be restarted at the last visited checkpoint. The robot will earn points when it reaches new checkpoints. Somewhere on the path, there will be a rectangular zone with walls (the evacuation zone). The evacuation zone is delimited in the entrance with a reflective silver tape strip attached to the floor and the exit with a strip of black tape.

Once in the evacuation zone, the robot should locate and transport the victims to the designated evacuation points. The victims are represented by **spheres with an off-center center of mass** <sup>[8]</sup> of 4 to 5 cm in diameter. The live victims are reflective silver which is electrically conductive, and the dead victims are black, which is not electrically conductive.

<sup>[9]</sup>The team can earn multipliers for victim evacuations depending on the <sup>[10]</sup>rescue order <sup>[11]</sup>. Be prepared to face obstacles, speed bumps, and debris in the evacuation zone. Still, the robot will not score points by negotiating these difficulties here. The robot should then exit the evacuation zone and follow the line until the goal tile of the course is reached.

# Changes from the 2023 RoboCupJunior Rescue Line Rules

- Deleted "The robot must transport rescue first aid kits that can be held from the beginning of the rescue or picked up on their way to the victims."
- Deleted ", together with the rescue kit,"
- Changed "15" to "20"
- Changed "15" to "20"
- Changed "gap" to "tile with one or more gaps"
- Changed "5" to "10"
- Changed "speed bump" to "tile with one or more speed bumps"
- Changed "balls" to "spheres with an off-center center of mass"
- Deleted "A rescue kit will be delivered to the live victims and transported to the designated evacuation point. "
- Deleted "difficulty level, "
- Deleted ", and rescue kit delivery"
- Added ", intersections, obstacles"
- Deleted "The robot must also place the rescue kit inside the green evacuation point."
- Deleted "Teams can choose between two different structures for evacuation points:"
- Deleted "Level one: The evacuation points are red and green triangles with a bump of 5mm along the side that does not touch a wall."
- Deleted "Level two: The evacuation points are red and green triangles with 6 cm walls and a hollow center."
- Deleted "The chosen level is applied for both red and green evacuation points."
- Added "The evacuation points are red and green triangles with 6 cm walls and a hollow center."
- Deleted "by rolling a dice"
- Deleted "roll the dice again and "
- Changed "ball with" to "sphere with an off-center center of mass and"
- Added "at least 4 weeks"
- Added "All teams must submit a Poster file before the competition and bring a physical Poster to the competition venue. The Poster is a public document that will be shared with the community during the Poster Presentation session at the competiiton venue. A template for the Poster and rubrics are available on the <https://junior.robocup.org/rcj-rescue-line/>[RoboCupJunior Official website]."
- Added "The deadline for delivering the documents is scheduled for 3 weeks before the first day of the competition."
- Deleted "Teams must choose level one or two separately for the evacuation point and the rescue kit before the start of the game."

- Deleted "Once a robot begins its scoring run, the referee will roll a standard 6-sided dice to determine in which corner the evacuation points will be located."
- Deleted "The rescue kit will be left in the exact location (even if it is located on the robot) when a lack of progress is called."
- Changed "gap" to "tile with one or more gaps"
- Changed "5" to "10"
- Changed "speed bump" to "tile with one or more speed bumps"
- Changed "15" to "20"
- Changed "15" to "20"
- Added "or stops on the goal tile"
- Deleted "to reach the checkpoint"
- Deleted ".. --Level one evacuation point:"
- Deleted "\* (SLVR) =  $\times 1.2$  per successful rescue of a living victim."
- Deleted "\* (SDVR) =  $\times 1.2$  per successful rescue of the dead victim if both living victims have already been successfully evacuated."
- Deleted ".. Level two evacuation point:"
- Deleted ".. Level one evacuation point: (EZLP) =  $-0.025 \times$  (number of lack of progresses in the area containing an evacuation zone)"
- Deleted "Level two evacuation point: "
- Deleted "An additional multiplier will be awarded for the rescue kit placed completely inside the green evacuation point, as such:"
- Deleted "\* Level one evacuation point & Level one rescue kit: (RK) =  $\times 1.1$ "
- Deleted "\* Level one evacuation point & Level two rescue kit: (RK) =  $\times 1.3$ "
- Deleted "\* Level two evacuation point & Level one rescue kit: (RK) =  $\times 1.2$ "
- Deleted "\* Level two evacuation point & Level two rescue kit: (RK) =  $\times 1.6$ "
- Added "Competition"
- Added "The deadline for delivering the documents is scheduled for 3 weeks before the first day of the competition through an online form."
- Rescue Kit Section deleted



# Contents

- 1. Code of Conduct.....8
  - 1.1. Spirit..... 8
  - 1.2. Fair Play ..... 8
  - 1.3. Behavior..... 8
  - 1.4. Mentors..... 8
  - 1.5. Ethics and Integrity..... 9
  - 1.6. Sharing..... 9
- 2. Field ..... 9
  - 2.1. Description..... 9
  - 2.2. Floor..... 10
  - 2.3. Line..... 10
  - 2.4. Checkpoints..... 11
  - 2.5. Speed Bumps, Debris, and Obstacles.....11
  - 2.6. Intersections and Dead Ends .....11
  - 2.7. Ramps.....12
  - 2.8. Seesaws ..... 12
  - 2.9. Evacuation Zone .....13
  - 2.10. Victims ..... 14
  - 2.11. **Rescue Kit** ..... 14
  - 2.12. Environmental Conditions ..... 14
- 3. Robots..... 14
  - 3.1. Control.....14
  - 3.2. Construction..... 15
  - 3.3. Team ..... 15
  - 3.4. Inspection ..... 16
  - 3.5. Violations..... 17
- 4. Play .....17
  - 4.1. Pre-game Practice..... 17
  - 4.2. Humans ..... 17
  - 4.3. Start of Game..... 17
  - 4.4. Scoring Run.....18
  - 4.5. Lack of Progress..... 18
  - 4.6. Scoring..... 19
  - 4.7. End of Game.....21
- 5. **Competition**..... 22
  - 5.1. Rounds & Scoring.....22
  - 5.2. Technical Challenge..... 23



5.3. SuperTeam Challenge .....	23
6. Open Technical Evaluation.....	23
6.1. Description.....	24
6.2. Evaluation Aspects.....	24
6.3. Sharing.....	25
7. Conflict Resolution.....	25
7.1. Referee and Referee Assistant.....	25
7.2. Rule Clarification .....	25
7.3. Special Circumstances.....	25



# 1. Code of Conduct

## 1.1. Spirit

1. It is expected that all participants (students and mentors alike) respect the aims and ideals of RoboCupJunior as set out in our mission statement.
2. The volunteers, referees, and officials will act within the event's spirit to ensure the competition is competitive, fair, and, most importantly, fun.
3. **It is not whether you win or lose but how much you learn that counts!**

## 1.2. Fair Play

1. Robots that cause deliberate or repeated damage to the field will be disqualified.
2. Humans who cause deliberate interference with robots or damage the field will be disqualified.
3. It is expected that all teams aim to participate fairly.

## 1.3. Behavior

1. Each team is responsible for verifying the latest version of the rules on the RoboCupJunior Official website and additional clarifications/corrections on the official forum made by the RoboCupJunior Rescue Committee before the competition.
2. Participants should be mindful of other people and their robots when moving around the tournament venue.
3. Participants are not allowed to enter setup areas of other leagues or teams unless explicitly invited to do so by team members.
4. Teams will be responsible for checking updated information (schedules, meetings, announcements, etc.) during the event. The RoboCupJunior Rescue Committee will provide updated information on notice boards in the venue, the local competition website, or the RoboCupJunior website if possible.
5. Participants and their companions who misbehave may be asked to leave the venue and risk being disqualified from the tournament.
6. Referees, officials, tournament organizers, and local law enforcement authorities will enforce these rules equally to all participants.
7. Teams are expected to be at the venue early on the setup day as important activities will occur. These activities include but are not limited to registration, participation raffle, interviews, captains, and mentor's meetings, among others.

## 1.4. Mentors

1. Non-team members (mentors, teachers, parents and other family, chaperones, translators, and other adult team members) are not allowed in the student work area.

2. Mentors are not permitted to be involved in building, repairing, or programming their team's robots before and during the competition.
3. In the first instance, mentor interference with robots or referee decisions will result in a warning. If this behavior recurs, the team could face a possible elimination from the tournament.
4. Robots have to be the work of the students. Any robot that appears identical to another robot may be prompted for re-inspection.

## 1.5. Ethics and Integrity

1. Fraud and misconduct are not condoned. Fraudulent acts may include the following:
  - a. Mentors working on the software or hardware of student's robot(s) during the competition.
  - b. More experienced/advanced groups of students may provide advice but should not do the work for other groups. Otherwise, the team risks being disqualified.
2. RoboCupJunior reserves the right to revoke an award if fraudulent behavior is proven after the award ceremony occurs.
3. Suppose it is evident that a mentor intentionally violates the code of conduct and modifies and works on the student's robot(s) during the competition. In that case, the mentor will be banned from future participation in RoboCupJunior competitions.
4. Teams that violate the code of conduct can be disqualified from the tournament. Disqualifying a single team member from further participation in the tournament is also possible.
5. Referees, officials, tournament organizers, and local law enforcement authorities will give a team a warning in less severe cases of violations of the code of conduct. A team can be disqualified immediately without warning for severe or repeated violations of the code of conduct.

## 1.6. Sharing

1. The spirit of world RoboCup competitions is that teams should share technological and curricular developments with other participants after the tournament. Sharing furthers the mission of RoboCupJunior as an educational initiative.
2. The RoboCupJunior Rescue Committee may publish developments on the RoboCupJunior website after the event.
3. Participants are strongly encouraged to ask questions to their fellow competitors to foster a culture of curiosity and exploration in the fields of science and technology.

# 2. Field

## 2.1. Description

1. The field comprises modular tiles, which the organizers can use to make an endless number of courses for the robots to traverse.

2. The field will consist of 30 cm x 30 cm tiles with different patterns. The organizers will not reveal the final selection of tiles and their arrangement until the day of the competition. Competition tiles may be mounted on a hard-backing material of any thickness.
3. There will be a minimum of 8 tiles in a competition field, excluding the start and goal tiles.
4. There are different tile designs (teams can find examples under [2.3](#)).

## 2.2. Floor

1. The floor is white. The floor may be either smooth or textured (like linoleum or carpet) and may have steps of up to 3 mm in height between tiles. Due to the nature of the tiles, there may be a step or gaps in the construction of the field.
2. Competitors should be aware that tiles may be mounted on thick backing or raised off the ground, making it difficult to get back on a tile where the robot comes off the course. No provision will be made to assist robots that drive off a tile to get back onto the tile.
3. Robots must be designed to navigate under tiles that form bridges over other tiles. Tiles placed above other tiles will be supported by pillars at tile corners with a square cross-section of 25mm x 25mm, making each tile entrance/exit 25 cm. The minimum height (space between the floor and the ceiling) will be 25 cm.

## 2.3. Line

1. The black line, 1-2 cm wide, may be made with standard electrical insulating tape or printed onto paper or other materials. The black line forms a path on the floor. (The grid lines indicated in the drawings below are for reference only, and competitors can expect tiles to be added or omitted.)
2. Straight sections of the black line may have gaps with at least 5 cm of the straight line before each gap as measured from the shortest portion of the straight part of the line. The length of a gap will be no more than 20 cm.
3. The arrangement of the tiles and paths may vary between rounds.
4. The line will be 10 cm away from any edge of the field, walls, pillars to support ramps, seesaws, and obstacles that do not lie ahead of the robot's path.
5. The line will end with a goal tile with a 25mm x 300mm strip of red tape in the center of the tile, perpendicular to the incoming line.

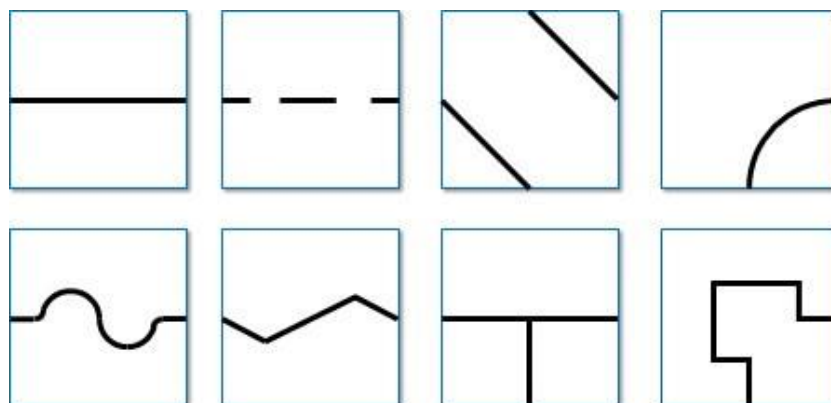

## 2.4. Checkpoints

1. A checkpoint is a tile in which a robot will be manually placed back when a lack of progress occurs.
2. Checkpoints will not be located on tiles with scoring elements.
3. The start tile is a checkpoint where the robot can restart.
4. A checkpoint marker is a marker that indicates for humans which tiles are checkpoints. A disk with 5 mm to 12 mm thickness and up to 70 mm in diameter has been used frequently. Still, it can be different depending on the organizer.
5. The field designers will predetermine the number of checkpoint markers and their locations.

## 2.5. Speed Bumps, Debris, and Obstacles

1. Speed bumps will have a height of 1 cm or less and be white. When the speed bump is placed over any black line, the overlap between the speed bump and the black line will be colored black. The organizers will fix speed bumps on the floor.
2. Speed bumps may also be placed anywhere in the evacuation zone. Speed bumps in evacuation zone are not scored.
3. Debris will have a maximum height of 3 mm. The organizers will not fix it to the floor. The debris consists of small materials such as toothpicks, small wooden dowels, etc.
4. Obstacles may include bricks, blocks, weights, and other large, heavy items. Obstacles will be at least 15 cm high and can be fixed to the floor.
5. An obstacle will not occupy more than one line or tile.
6. A robot is expected to navigate around obstacles. The robot may move obstacles, but obstacles may be very heavy or fixed to the floor. Obstacles will remain where they were moved to, even if that prevents the robot from proceeding.
7. Obstacles will not be placed closer than 25 cm from the edge of the field (including edges of tiles that are elevated by ramps) and inclined tiles.
8. In the evacuation zone, obstacles may be placed anywhere with a minimum of 10 cm clearance from the wall. Obstacles in the evacuation zone are not scored.

## 2.6. Intersections and Dead Ends

1. The organizers can place intersections anywhere except in the evacuation zone.
2. Intersections markers are green and 25 mm x 25 mm in dimension. They indicate the direction of the path the robot should follow.
3. The robot should continue straight ahead if there is no green marker at an intersection.
4. A dead end is when there are two green marks before an intersection (one on each side of the line); in this case, the robot should turn around.
5. The intersections are always perpendicular but may have 3 or 4 branches.

6. Intersection markers will be placed just before the intersection. See the images below for possible scenarios.

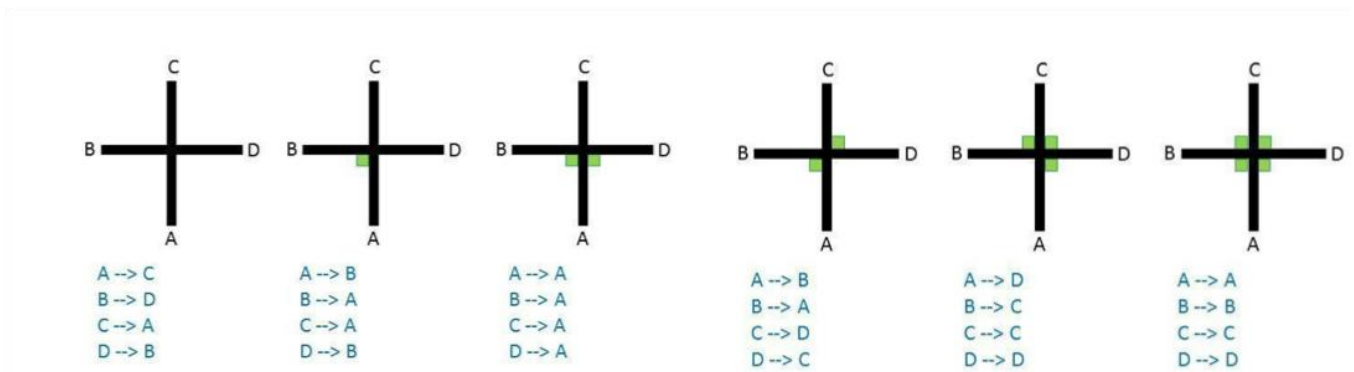
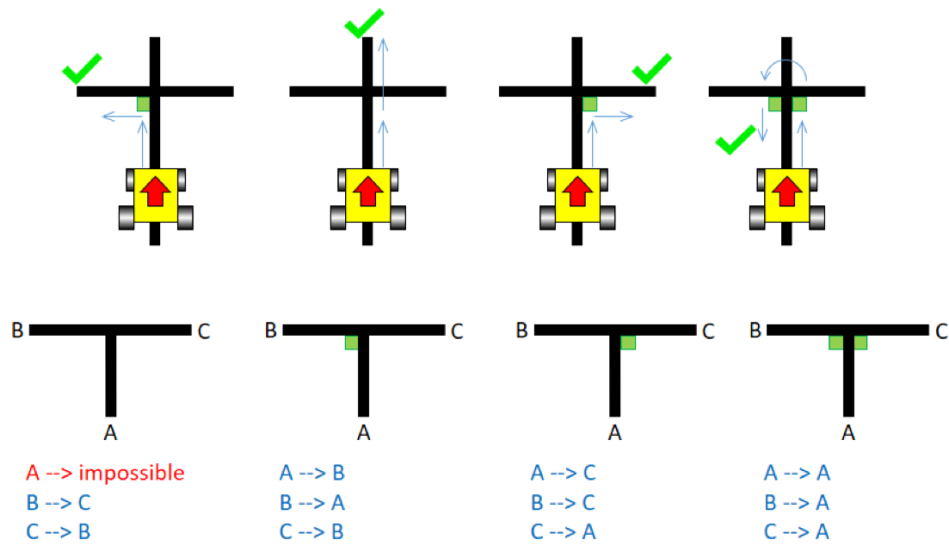

## 2.7. Ramps

1. Tiles will be used as ramps to allow the robots to 'climb' up and down from different levels.
2. Ramps will not exceed an incline of 25 degrees from the horizontal.
3. More than one tile may be used to build one ramp up or down. Despite the number of tiles used in the construction, the ramp will be scored as one ramp as it takes from one level to another.
4. The ramp will be scored when the robot reaches the horizontal tile at the upper level after an ascending ramp or the horizontal tile at the bottom level after a descending ramp.
5. The line along the ramps can contain gaps, speed bumps, **intersections**, **obstacles** and debris.

## 2.8. Seesaws

1. A seesaw is a tile that can pivot around a hinge in the center of a regular tile.
2. The seesaw will have an incline less than 20 degrees when tilted to one side.
3. The seesaw tile will have a straight line with no scoring elements present.

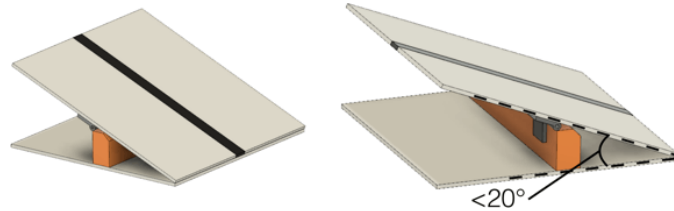

## 2.9. Evacuation Zone

1. The black line will end at the entrance of the evacuation zone.
2. The black line will begin again at the exit of the evacuation zone.
3. The evacuation zone is 120 cm by 90 cm with walls around the four sides at least 10 cm high and colored white.
4. At the entrance to the evacuation zone, there is a 25 mm × 250 mm strip of reflective silver tape on the floor.
5. At the exit of the evacuation zone, there is a 25 mm × 250 mm strip of black tape on the floor.
6. The organizers may place an obstacle inside the evacuation zone. In the evacuation zone, organizers may put the obstacle anywhere with a minimum of 10 cm clearance from the wall. Obstacles in the evacuation zone are not scored.
7. Safe evacuation points are defined by right-angled triangles with sides of 30 cm x 30 cm.
  - a. There will be one red evacuation point where the dead victim must be placed by the robot and,
  - b. There will be one green evacuation point where the living victims must be placed by the robot. <sup>[12]</sup>
8. <sup>[13]</sup>
  - a. <sup>[14]</sup>
  - b. <sup>[15]</sup>
9. <sup>[16]</sup>
10. **The evacuation points are red and green triangles with 6 cm walls and a hollow center.**
11. The referee can randomly place the evacuation points in any non-entry/exit corners in the evacuation zone <sup>[17]</sup>.
12. After a Lack of Progress, the referee may <sup>[18]</sup>place the evacuation points in new corners.
13. The organizers will fix the evacuation points to the floor. Still, teams should be prepared for slight movements in the evacuation points.



## 2.10. Victims

1. Organizers may locate victims anywhere on the floor of the evacuation zone.
2. A victim represents a person and is in the form of a 4-5 cm diameter **sphere with an off-center center of mass and** <sup>[19]</sup> a maximum weight of 80 g.
3. There are two types of victims:
  - a. Dead victims are black and not electrically conductive.
  - b. Living victims are silver, reflect light, and are electrically conductive.
4. Organizers will locate the victims randomly in the evacuation zone. There will be precisely two live victims and one dead victim placed in the evacuation zone.

## 2.11. Rescue Kit

<sup>[20]</sup>

## 2.12. Environmental Conditions

1. The environmental conditions at a tournament may differ from those at home. Teams must come prepared to adjust their robots to the conditions at the venue.
2. Lighting and magnetic conditions may vary in the rescue field.
3. The field may be affected by magnetic fields (e.g., under-floor wiring and metallic objects). Teams should prepare their robots to handle such interference.
4. The field may be affected by unexpected lighting interference (e.g., camera flash from spectators). Teams should prepare their robots to handle such interference.
5. All measurements in the rules have a tolerance of  $\pm 10\%$ .

# 3. Robots

## 3.1. Control

1. Robots must be controlled autonomously. Using a remote control, manual control, or passing information (by external sensors, cables, wirelessly, etc.) to the robot is not allowed.
2. Robots must be started manually by the team captain.
3. Any pre-mapped type of dead reckoning (movements preprogrammed based on known locations or placement of features in the field) is prohibited.
4. Robots must not damage any part of the field in any way.

## 3.2. Construction

1. Any robot kit or building blocks, either available on the market or built from raw hardware, may be used as long as the design and construction of the robot are primarily and substantially the students' original work.
2. Teams are not permitted to use commercially produced robot kits or sensors components specifically designed or marketed to complete any single primary task of RoboCupJunior Rescue. Robots that do not comply will face immediate disqualification from the tournament. If there is any doubt, teams should consult the RoboCupJunior Rescue Committee before the competition.
3. Only lasers from classes 1 and 2 are allowed for the safety of participants and spectators. The organizers will check this during the inspection. Teams using lasers must have the datasheet of the laser and submit them before the competition and be able to show them during the competition.
4. Wireless communication must be used as described on the [RoboCupJunior General Rules](#). Robots performing other types of wireless communication need to be deleted or disabled. If the robot has other wireless communication equipment, the team must prove they are disabled. Non-conforming robots may be immediately disqualified from the tournament.
5. Robots may incur damage by falling off the field, making contact with another robot, or contacting field elements. The RoboCupJunior Rescue Committee cannot anticipate all potential situations where damage to the robot may occur. Teams should ensure that all active elements on a robot are adequately protected with resistant materials. For example, teams must protect electrical circuits from all human contact and direct contact with other robots and field elements.
6. When batteries are transported, moved, or charged, it is strongly recommended that safety bags be used. Reasonable efforts should be made to ensure that robots avoid short circuits and chemical or air leaks.
7. **Robots must be equipped with a handle that is to be used to pick them up during the scoring run.**
8. **Robots must be equipped with a single physical binary switch/button (with exception of buttons that are a part of commercial controller), clearly visible to the referee, for starting the robot at the beginning of run and when a lack of progress occurs. Procedure performed after LoP occurs can only include this button and at most one more switch for cutting the power. Team has to notify the referee about their LoP procedure before each scoring run, and only this procedure is allowed to be performed after a LoP.**

## 3.3. Team

1. Each team must have only one robot on the field.
2. Each team must comply with the [RoboCupJunior General Rules](#) regarding the number of members and each member's age.
3. Each team member must explain their work and have a specific technical role.
4. A student can be registered on only one team across all RoboCupJunior leagues/sub-leagues.
5. A team can only participate in one league/sub-league across all RoboCupJunior leagues/sub-leagues.



6. Team members may compete in Rescue Line twice (2 international events). After competing in Rescue Line twice, they must move to another RoboCupJunior sub-league.
7. Mentors/parents are not allowed to be with the students during the competition. The students will have to govern themselves (without a mentor's supervision or assistance) during the long stretch of hours at the competition.

### 3.4. Inspection

1. A panel of referees will scrutinize the robots before the start of the tournament and at other times during the competition to ensure that they meet the constraints described in these rules.
2. Using a robot similar to another team's robot from a previous year or the current year is illegal.
3. The team's responsibility is to have their robot re-inspected if modified at any time during the tournament.
4. Students will be asked to explain their robot's operation to verify that its construction and programming are their own work.
5. Students will be asked about their preparation efforts. The RoboCupJunior Rescue Committee may request them to answer surveys and participate in videotaped interviews for research purposes.
6. All teams must complete a web form before the competition to allow referees to prepare better for the interviews. The RoboCupJunior Rescue Committee will provide instructions on submitting the form to the teams **at least 4 weeks** before the competition.
7. All teams must submit their Technical Description Paper (TDP) before the competition. The TDP is a public document that will be shared with the community. A template for the TDP and rubrics are available on the [RoboCupJunior Official website](#).
8. All teams have to submit their source code before the competition. The organizers will not share the source code with other teams without the team's permission. The organizers will request permission at the registration.
9. All teams must submit their Engineering Journal before the competition. The organizers will not share the journals with other teams without the team's permission. The organizers will request permission at the registration. A guide for the Engineering Journal format and rubrics are available on the [RoboCupJunior Official website](#).



However, it is highly recommended that teams publicly share their Engineering Journal. The RoboCupJunior Rescue Committee will share the team's journals alongside their poster presentation and TDP through the RoboCupJunior Forum of the teams that provided their consent. The aim is that other teams could learn from them.

10. **All teams must submit a Poster file before the competition and bring a physical Poster to the competition venue. The Poster is a public document that will be shared with the community during the Poster Presentation session at the competition venue. A template for the Poster and rubrics are available on the [RoboCupJunior Official website](#).**
11. **The deadline for delivering the documents is scheduled for 3 weeks before the first day of the**

**competition.**

## 3.5. Violations

1. Any violations of the inspection rules will prevent the offending robot from competing until modifications are made, and the robot passes inspection.
2. Teams must make modifications within the schedule of the tournament, and teams cannot delay tournament play while making modifications.
3. Suppose a robot fails to meet all specifications (even with modifications). In that case, it will be disqualified from that game (but not from the tournament).
4. No mentor assistance is allowed during the competition. (see 1.4.)
5. Any rule violations may be penalized by disqualification from the tournament or the game or result in a loss of points at the discretion of the referees, officials, or RoboCupJunior Rescue Committee.

## 4. Play

### 4.1. Pre-game Practice

1. When possible, teams will have access to practice fields for calibration and testing throughout the competition.
2. Whenever there are dedicated independent fields for competition and practice, it is at the organizers' discretion if testing is allowed on the competition fields.

### 4.2. Humans

1. Teams should designate one of their members as 'captain' and another as 'co-captain'. Only these two team members will be allowed access to the competition fields unless directed by a referee. Only the captain can interact with the robot during a scoring run.
2. The captain can move the robot only when they are told to do so by a referee.
3. Other team members (and any spectators) within the vicinity of the competition field must stand at least 150 cm away from the field unless directed by a referee.
4. No one is allowed to touch the fields intentionally during a scoring run.
5. All pre-mapping activities will immediately disqualify the robot for the round. Pre-mapping is the act of humans providing the robot with information about the field (e.g., location of obstacles, entrance to the evacuation zone, number of tiles after the evacuation zone, etc...) before the game.

### 4.3. Start of Game

1. <sup>[21]</sup>
2. Each team has a maximum of 8 minutes for a game. The game includes the time for calibration and

the scoring run.

3. Calibration is taking sensor readings and modifying the robot's programming to accommodate such sensor readings. Calibration does not count as pre-mapping.
4. The scoring run is defined as the time when the robot is moving autonomously to navigate the field, and the referee will record the scores.
5. A game begins at the scheduled starting time, whether or not the team is present or ready. Start times will be posted around the venue.
6. Once the game has begun, the robot is not permitted to leave the competition area.
7. Teams may calibrate their robot in as many locations as desired on the field, but the clock will continue to run. Robots are not permitted to move on their own while calibrating.
8. Once a team is ready to start a scoring run, the team must notify the referee. To start a scoring run, the robot is placed on the start tile of the course, as indicated by the referee. Once a scoring run has begun, no more calibration is permitted, including changing code/code selection.
9. Teams may choose not to calibrate the robot and immediately start the scoring run instead.
10. <sup>[22]</sup>
11. Individual tiles, obstacles, and other scoring elements may be removed, added, or changed when the robot starts moving; to prevent teams from pre-mapping the layout of the fields. These changes may happen based on a die rolled by the referee or with another method of randomization announced by the organizers. For a particular field during a round, the referee will ensure the difficulty of the field will be kept similar, and the maximum points are constant.

## 4.4. Scoring Run

1. Robots will start behind the joint of the start tile and the subsequent tile along the course. The referee will check the correct placement.
2. Modifying the robot during a scoring run is prohibited, which includes remounting parts that have fallen off.
3. Any parts the robot loses intentionally or unintentionally will be left in the field until the run is over. Team members and referees cannot move or remove elements from the field during a scoring run.
4. Teams cannot give their robot any information about the field. A robot is supposed to recognize the field elements by itself.
5. The robot must follow the course completely to enter the evacuation zone and then out of the evacuation zone towards the goal tile.
6. The robot has reached a tile when more than half the robot is within that tile when viewed from above and robot is actively following the line at that point in time.

## 4.5. Lack of Progress

1. A lack of progress occurs when:
  - a. a team captain declares a lack of progress.

- b. a robot loses the black line without regaining it by the next tile in the sequence (see figures at the end of the section).
  - c. a robot reaches a line that is not in the intended sequence.
2. If a lack of progress occurs, the robot must be positioned on the previous checkpoint tile facing the path towards the goal tile and checked by the referee.
  3. After a lack of progress, only the LoP procedure explained to the referee before the run start is allowed to be performed (see 3.2.8).
  4. There is no limit to the lack of progress within a round.
  5. After three failed attempts to reach a checkpoint, a robot is allowed to proceed to the next checkpoint.
    - a. The team captain may make further attempts at the course to earn additional points from scoring elements that have not already been earned before reaching the next checkpoint.
  6. Suppose a lack of progress occurs in the evacuation zone. In that case, all victims (including ones that have rolled) will remain in their current position. Victims that are held by the robot will be placed roughly on the robot's location when a lack of progress occurs in the evacuation zone. Suppose a lack of progress occurs as the robot exits the evacuation zone while carrying victims. In that case, the victims will be randomly placed in the evacuation zone.
  7. <sup>[23]</sup>
  8. Any seesaws ahead of the robot's path can be moved in a favorable direction when a lack of progress is called.

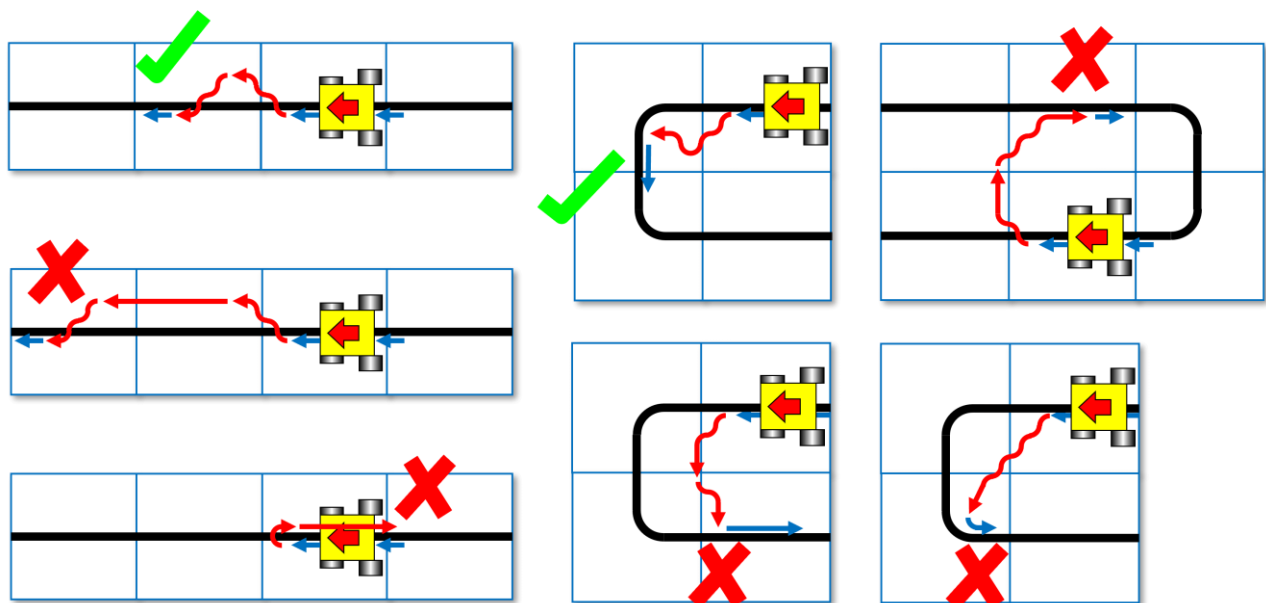

## 4.6. Scoring

1. A robot is awarded points for successfully navigating each hazard (gaps in the line, speed bumps, intersections, dead ends, ramps, obstacles, and seesaws). Points are awarded per hazard when the robot has reached the next tile in sequence. A ramp as a hazard accounts for all inclined tiles that make up one ramp. Point allocations are 10 points per **tile with one or more gaps** <sup>[24]</sup>, **10** <sup>[25]</sup> points

per **tile with one or more speed bumps** <sup>[26]</sup>, 10 points per intersection/dead end, 10 points per ramp, **20** <sup>[27]</sup> points per obstacle, and **20** <sup>[28]</sup> points per seesaw.

2. Failed attempts at navigating hazards in the field are defined as a Lack of Progress (see 4.5).
3. When a robot reaches a checkpoint tile **or stops on the goal tile**, it will earn points for each tile it has passed since the previous checkpoint. The points per tile depend on how many attempts the robot has made : <sup>[29]</sup>
  - ⋅ 1st attempt = 5 points/tile
  - ⋅ 2nd attempt = 3 points/tile
  - ⋅ 3rd attempt = 1 point/tile
  - ⋅ Beyond the 3rd attempt = 0 points/tile

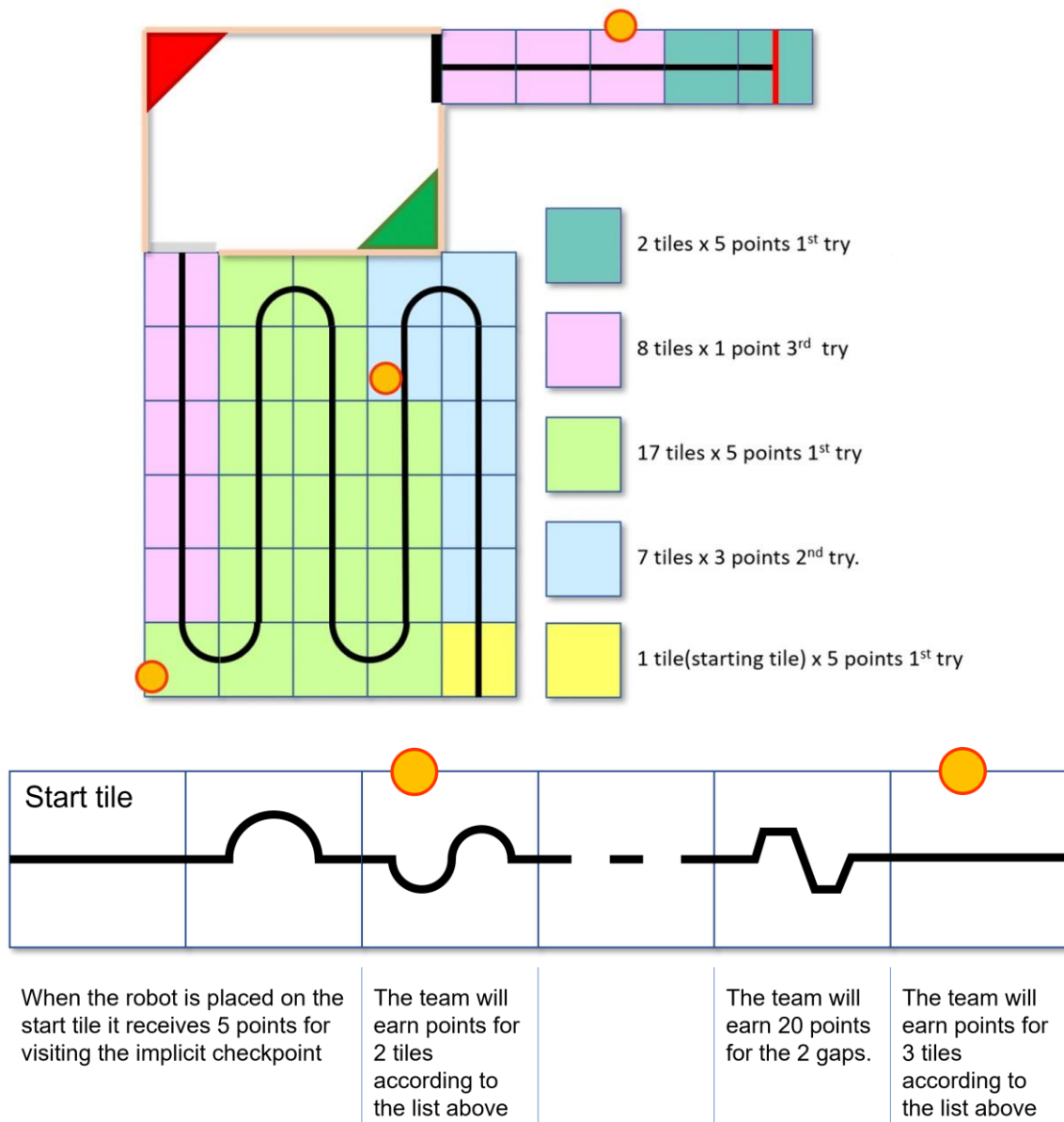

4. Each gap, speed bump, intersection, dead end, ramp, obstacle, and seesaw can only be scored once per intended direction through the course. Points are not awarded for subsequent attempts through the course.

5. The referees will not count any hazards in the evacuation zone towards additional points.
6. Successful victim rescue (SVR): Robots are awarded multipliers for successfully rescuing victims. A successful victim rescue occurs when the victim is entirely moved into the designated evacuation point, and no part of the robot can be in contact with the victim. When the referee determines there has been a successful victim rescue, the referee will remove the victim from the evacuation point to allow more victims to be evacuated. The multipliers are allocated as such:

[30], [31], [32], [33]

- (SLVR) =  $\times 1.4$  per successful rescue of a living victim.
- (SDVR) =  $\times 1.4$  per successful rescue of the dead victim if both living victims have already been successfully evacuated.

7. Only the victims placed by the robot at the appropriate evacuation point will be awarded multipliers.
8. When a lack of progress occurs between checkpoints (or a checkpoint and the goal) containing an evacuation zone, each of the (SVR) obtained multipliers will be deducted: [34]

a. [35](EZLP) =  $-0.05 \times$  (number of lack of progresses in the area containing an evacuation zone)

9. Multipliers will never be lower than 1.25.

10. [36], [37], [38], [39], [40]

11. The evacuation zone multiplier is, thus, combined as:

$$\begin{aligned}
 (\text{EVACUATION ZONE MULTIPLIER}) = & \\
 & ((\text{SLVR})+(\text{EZLP}))_1 \quad | \text{ Successful rescue of the first living victim} \\
 & \times ((\text{SLVR})+(\text{EZLP}))_2 \quad | \text{ Successful rescue of the second living victim} \\
 & \times ((\text{SDVR})+(\text{EZLP})) \quad | \text{ Successful rescue the dead victim}
 \end{aligned}$$

12. An exit bonus is awarded when the robot has reached the goal tile and has completely stopped for more than 5 seconds (this time is included in the total 8 minutes). The exit bonus is a non-negative number and is given by

$$(\text{EXIT BONUS}) = 60 - 5 \times (\text{number of total lack of progress})$$

13. The multipliers from successful evacuations are multiplied by the score obtained from the line tracing course.

$$(\text{FIELD SCORE}) = (\text{LINE TRACING SCORE} + \text{EXIT BONUS}) \times (\text{EVACUATION ZONE MULTIPLIER})$$

## 4.7. End of Game

1. A team may elect to stop the game early at any time. In this case, the team captain must indicate the team's desire to terminate the game to the referee. The team will be awarded all points earned up to the call for the end of the game. The referee will stop the time at the end of the game, which will be

recorded as the game time.

2. The game ends when:
  - a. the 8 minutes of allowed game time expires
  - b. the team captain calls the end of the game
  - c. the robot reaches the goal tile and completely stops for 5 seconds

## 5. Competition

This chapter outlines the structure of an international RoboCupJunior Rescue competition. The competition format and the inclusion of elements like rubrics based scoring, Technical Challenges and the SuperTeam Challenge may vary in local, regional and super-regional competitions. Please refer to the respective organiser for details.

### 5.1. Rounds & Scoring

1. The competition will consist of multiple rounds of which the worst one or more will be omitted from the final score. The worst round is defined by the lowest normalized field score of the team.
2. The field score for every round will be normalized with the score of the best team of that round:

$$(\text{NORMALIZED FIELD SCORE}) = (\text{FIELD SCORE}) / (\text{BEST FIELD SCORE})$$

3. The normalized field scores will be used to calculate the mean. The worst round(s) will not be considered here:

$$(\text{MEAN OF NORMALIZED FIELD SCORES}) = (\text{SUM OF NORMALIZED FIELD SCORES EXCLUDING OMITTED ROUNDS}) / (\text{NUMBER OF ROUNDS} - \text{NUMBER OF OMITTED ROUNDS})$$

4. The normalized rubrics score is made up of a sum of normalized scores for the individual rubrics as follows:

$$\begin{aligned} (\text{NORMALIZED RUBRICS SCORE}) = & \\ & 0.4 \times (\text{TDP SCORE}) / (\text{BEST TDP SCORE}) \\ & + 0.4 \times (\text{ENGINEERING JOURNAL SCORE}) / (\text{BEST ENGINEERING JOURNAL SCORE}) \\ & + 0.2 \times (\text{POSTER SCORE}) / (\text{BEST POSTER SCORE}) \end{aligned}$$

5. The Rubrics for TDP, Engineering Journal, and Poster will be available on the RoboCupJunior website and the RCJ Rescue Community website.
6. The score from the Technical Challenge will be normalized with the score of the best team:

$$(\text{NORMALIZED TECHNICAL CHALLENGE SCORE}) = (\text{TECHNICAL CHALLENGE SCORE}) / (\text{BEST TECHNICAL$$

## CHALLENGE SCORE)

7. The final score is made up of a weighted sum of normalized scores from the field score, the rubrics and the Technical Challenge as such:

$$\begin{aligned} \text{(TOTAL SCORE)} = & \\ & 0.7 \times \text{(MEAN OF NORMALIZED FIELD SCORES)} \\ & + 0.2 \times \text{(NORMALIZED RUBRICS SCORE)} \\ & + 0.1 \times \text{(NORMALIZED TECHNICAL CHALLENGE SCORE)} \end{aligned}$$

8. Ties in scoring will be resolved based on the mean of normalized field scores.

## 5.2. Technical Challenge

The Technical Challenge is an additional part of the competition where the teams' ability to quickly modify the behaviour of their robot will be tested. It consists of one or more mini-tasks with only a limited timespan to solve.

1. The Technical Challenge will take place after the scoring runs have ended.
2. The rules of the individual parts of the Technical Challenge will not be announced before the competition. The teams will only have limited time to prepare for the Challenge.
3. The timeframe for the completion of these tasks will be announced alongside the rules and scoring at a team meeting after the scoring runs.
4. The rules will require the teams to reprogram their robot to change its behaviour. There will be no hardware changes required compared to the main scoring runs.
5. The time given will correspond to the difficulty level of the tasks.

## 5.3. SuperTeam Challenge

The SuperTeam Challenge takes place independently of the main competition and won't influence the team's individual score. It has its own award and is focussed on the cooperation between the teams.

1. Each SuperTeam will consist of at least two teams. Teams coming from regions that share a native language will not be part of the same SuperTeam.
2. The rules of the SuperTeam Challenge will be announced at the competition and require the teams of each SuperTeam to work together.
3. The SuperTeam Challenge will require substantial software changes and may require minor hardware adjustments.

## 6. Open Technical Evaluation



## 6.1. Description

1. The organizers will evaluate your technical innovation during a dedicated time frame. All teams need to prepare for an open display during this time frame.
2. Judges will circulate and interact with the teams. The Open Technical Evaluation is intended to be a casual conversation with a question-and-answer atmosphere.
3. The Open Technical Evaluation's main objective is to emphasize the innovation's ingenuity. Innovative may mean technical advances compared to existing knowledge or an out-of-the-ordinary, simple but clever solution to existing tasks.

## 6.2. Evaluation Aspects

1. A standardized rubric system will be used, focusing on:
  - creativity
  - cleverness
  - simplicity
  - functionality
2. Your 'work' can include (but is not limited to) one of the following aspects:
  - creation of your own sensor instead of a pre-built sensor
  - creation of a 'sensor module' which is comprised of various electronics resulting in a self-contained module to provide a specific functionality
  - creation of a mechanical invention that is functional but out of the ordinary
  - creation of a new software algorithm for a solution
3. Teams must provide documents that explain their work. Each invention must be supported by concise but clear documentation. The documents must show precise steps towards the creation of the invention.
4. **The deadline for delivering the documents is scheduled for 3 weeks before the first day of the competition through an online form.**
5. Documents must include one Technical Description Paper (TDP), one poster and one Engineering Journal. Teams should be prepared to explain their work.
6. TDP should describe your team's project planning, robot's mechanical and electronics design, your software architecture and solutions and, the applied process on performance evaluation. A template for the TDP and rubrics are available on the [RoboCupJunior Official website](#).
7. Engineering Journals should demonstrate your best practices in the development process. A guide for the Engineering Journal format and rubrics are available on the [RoboCupJunior Official website](#).
8. The poster should include but is not limited to: the name of the team, country, league, robot description, robot capabilities, controller, the programming language used, sensors included, method of construction, time used for development, cost of materials, and awards won by the team in its country, etc. A guide for the poster format and rubrics are available on the [RoboCupJunior Official](#)

website.

## 6.3. Sharing

1. Teams are encouraged to review others' posters, TDPs and presentations.
2. Teams awarded certificates must post their documents and presentation online when the RoboCupJunior Rescue Committee asks.

# 7. Conflict Resolution

## 7.1. Referee and Referee Assistant

1. All decisions during gameplay are made by the referee or the referee assistant, who are in charge of the field, persons, and objects surrounding them.
2. During gameplay, the decisions made by the referee or the referee assistant are final.
3. After gameplay, the referee will ask the captain to sign the score sheet. Captains will be given a maximum of 1 minute to review the score sheet and sign it. By signing the score sheet, the captain accepts the final score on behalf of the entire team. In case of further clarification, the team captain should write their comments on the score sheet and sign it.

## 7.2. Rule Clarification

1. If any rule clarification is needed, please contact the [International RoboCupJunior Rescue Committee](#) through the [RoboCupJunior Forum](#).
2. If necessary, even during a tournament, a rule clarification may be made by members of the [International RoboCupJunior Rescue Committee](#).

## 7.3. Special Circumstances

1. If particular circumstances, such as unforeseen problems or capabilities of a robot occurs, rules may be modified by the RoboCupJunior Rescue Committee Chair in conjunction with available committee members, even during a tournament.
2. Suppose team captains/mentors do not attend the team meetings to discuss problems, and the resulting rule modifications described at [7.3.1](#). In that case, the organizers will understand that they agreed and were aware of the changes.

[1] In previous version this said "The robot must transport rescue first aid kits that can be held from the beginning of the rescue or picked up on their way to the victims."

[2] In previous version this said ", together with the rescue kit,"

[3] In previous version this said "15"

[4] In previous version this said "15"

[5] In previous version this said "gap"

[6] In previous version this said "5"

- [7] In previous version this said "speed bump"
- [8] In previous version this said "balls"
- [9] In previous version this said "A rescue kit will be delivered to the live victims and transported to the designated evacuation point. "
- [10] In previous version this said "difficulty level, "
- [11] In previous version this said ", and rescue kit delivery"
- [12] In previous version this said "The robot must also place the rescue kit inside the green evacuation point."
- [13] In previous version this said "Teams can choose between two different structures for evacuation points:"
- [14] In previous version this said "Level one: The evacuation points are red and green triangles with a bump of 5mm along the side that does not touch a wall."
- [15] In previous version this said "Level two: The evacuation points are red and green triangles with 6 cm walls and a hollow center."
- [16] In previous version this said "The chosen level is applied for both red and green evacuation points."
- [17] In previous version this said "by rolling a dice"
- [18] In previous version this said "roll the dice again and "
- [19] In previous version this said "ball with"
- [20] Rescue Kit Section deleted
- [21] In previous version this said "Teams must choose level one or two separately for the evacuation point and the rescue kit before the start of the game."
- [22] In previous version this said "Once a robot begins its scoring run, the referee will roll a standard 6-sided dice to determine in which corner the evacuation points will be located."
- [23] In previous version this said "The rescue kit will be left in the exact location (even if it is located on the robot) when a lack of progress is called."
- [24] In previous version this said "gap"
- [25] In previous version this said "5"
- [26] In previous version this said "speed bump"
- [27] In previous version this said "15"
- [28] In previous version this said "15"
- [29] In previous version this said "to reach the checkpoint"
- [30] In previous version this said ".. --Level one evacuation point:"
- [31] In previous version this said "\* (SLVR) =  $\times 1.2$  per successful rescue of a living victim."
- [32] In previous version this said "\* (SDVR) =  $\times 1.2$  per successful rescue of the dead victim if both living victims have already been successfully evacuated."
- [33] In previous version this said ".. Level two evacuation point:"
- [34] In previous version this said ".. Level one evacuation point: (EZLP) =  $-0.025 \times$  (number of lack of progresses in the area containing an evacuation zone)"
- [35] In previous version this said "Level two evacuation point: "
- [36] In previous version this said "An additional multiplier will be awarded for the rescue kit placed completely inside the green evacuation point, as such:"
- [37] In previous version this said "\* Level one evacuation point & Level one rescue kit: (RK) =  $\times 1.1$ "
- [38] In previous version this said "\* Level one evacuation point & Level two rescue kit: (RK) =  $\times 1.3$ "
- [39] In previous version this said "\* Level two evacuation point & Level one rescue kit: (RK) =  $\times 1.2$ "
- [40] In previous version this said "\* Level two evacuation point & Level two rescue kit: (RK) =  $\times 1.6$ "